

RoHS Compliant

[BOMcheck.net](https://www.bomcheck.net)

Color: ■

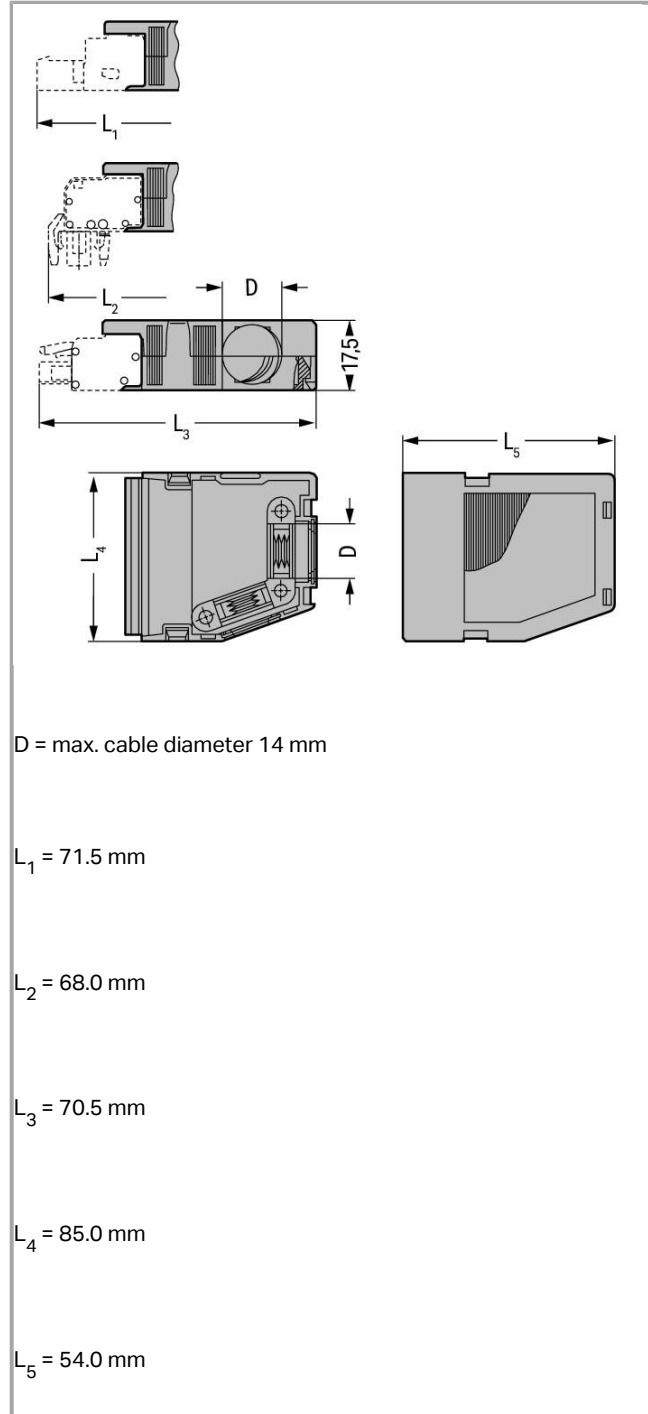

Item description

—

- Only for use with cable binders
- Cable binder width: max. 3.6 mm
- 1 x cable outlet, rear

Data

Connection data

No. of poles	3
Number of connection types	1

Geometrical Data

Pin spacing	5.08 mm / 0.2 inch
Width	18 mm / 0.709 inch
Height	17.5 mm / 0.689 inch
Depth	41.5 mm / 1.634 inch

Material Data

Color	orange
Fire load	0.138 MJ
Weight	4.8 g

Commercial data

Product Group	3 (Multi Conn. System)
Country of origin	DE
GTIN	4017332283090
Customs Tariff No.	85389099990

Approvals / Certificates

Country specific Approvals

Logo	Approval	Additional Approval Text	Certificate name
	KEMA/KEUR DEKRA Certification B.V.	EN 61984	2190761.01

Ship Approvals

Logo	Approval	Additional Approval Text	Certificate name
	ABS American Bureau of Shipping	-	14- HG1241537- PDA

UL-Approvals











Logo	Approval	Additional Approval Text	Certificate name
	UL UL International Germany GmbH	UL 1977	E45171















Compatible products

General accessories

	Item no.: 209-173 Fixing screw; for cable clamp; 7 or more poles		209-173
--	---	--	---------

Marking accessories

	Item no.: 2009-115 WMB-Inline; for Smart Printer; on reel; stretchable 5 - 5.2 mm; plain; snap-on type		2009-115
	Item no.: 2009-115/000-002 WMB-Inline; for Smart Printer; on reel; stretchable 5 - 5.2 mm; plain; snap-on type	/000-002	2009-115
	Item no.: 2009-115/000-006 WMB-Inline; for smartPRINTER; on reel; stretchable 5 - 5.2 mm; plain; snap-on type	/000-006	2009-115
	Item no.: 2009-115/000-007 WMB-Inline; for Smart Printer; on reel; stretchable 5 - 5.2 mm; plain; snap-on type	/000-007	2009-115
	Item no.: 2009-115/000-012 WMB-Inline; for smartPRINTER; on reel; stretchable 5 - 5.2 mm; plain; snap-on type	/000-012	2009-115
	Item no.: 2009-115/000-017 WMB-Inline; for Smart Printer; on reel; stretchable 5 - 5.2 mm; plain; snap-on type	/000-017	2009-115
	Item no.: 2009-115/000-023 WMB-Inline; for Smart Printer; on reel; stretchable 5 - 5.2 mm; plain; snap-on type	/000-023	2009-115
	Item no.: 2009-115/000-024 WMB-Inline; for smartPRINTER; on reel; stretchable 5 - 5.2 mm; plain; snap-on type	/000-024	2009-115
	Item no.: 793-501 WMB marking card; as card; not stretchable; plain; snap-on type		793-501
	Item no.: 793-501/000-002 WMB marking card; as card; not stretchable; plain; snap-on type	/000-002	793-501

	Item no.: 793-501/000-005 WMB marking card; as card; not stretchable; plain; snap-on type	/000-005	793-501
	Item no.: 793-501/000-006 WMB marking card; as card; not stretchable; plain; snap-on type	/000-006	793-501
	Item no.: 793-501/000-007 WMB marking card; as card; not stretchable; plain; snap-on type	/000-007	793-501
	Item no.: 793-501/000-012 WMB marking card; as card; not stretchable; plain; snap-on type	/000-012	793-501
	Item no.: 793-501/000-017 WMB marking card; as card; not stretchable; plain; snap-on type	/000-017	793-501
	Item no.: 793-501/000-023 WMB marking card; as card; not stretchable; plain; snap-on type	/000-023	793-501
	Item no.: 793-501/000-024 WMB marking card; as card; not stretchable; plain; snap-on type	/000-024	793-501
	Item no.: 793-5501 WMB marking card; as card; for terminal block width 5 - 17.5 mm; stretchable 5 - 5.2 mm; plain; snap-on type		793-5501
	Item no.: 793-5501/000-002 WMB marking card; as card; for terminal block width 5 - 17.5 mm; stretchable 5 - 5.2 mm; plain; snap-on type	/000-002	793-5501
	Item no.: 793-5501/000-005 WMB marking card; as card; stretchable 5 - 5.2 mm; plain; snap-on type	/000-005	793-5501
	Item no.: 793-5501/000-006 WMB marking card; as card; stretchable 5 - 5.2 mm; plain; snap-on type	/000-006	793-5501
	Item no.: 793-5501/000-007 WMB marking card; as card; stretchable 5 - 5.2 mm; plain; snap-on type	/000-007	793-5501
	Item no.: 793-5501/000-012 WMB marking card; as card; stretchable 5 - 5.2 mm; plain; snap-on type	/000-012	793-5501
	Item no.: 793-5501/000-014 WMB marking card; as card; stretchable 5 - 5.2 mm; plain; snap-on type	/000-014	793-5501
	Item no.: 793-5501/000-017 WMB marking card; as card; stretchable 5 - 5.2 mm; plain; snap-on type	/000-017	793-5501



Item no.: 793-5501/000-023

WMB marking card; as card; stretchable 5 - 5.2 mm; plain; snap-on type

/000-023

793-5501



Item no.: 793-5501/000-024

WMB marking card; as card; stretchable 5 - 5.2 mm; plain; snap-on type

/000-024

793-5501

Downloads

CAD/CAE - Smart Data

CAD data

3D Download 232-633

URL

Download

Subject to changes.